



INSTALLATION INSTRUCTIONS

www.vikingbags.com



888-208-1949 |



support@vikingbags.com

VIKING LAMELLAR SLANTED HARD SADDLEBAGS INSTRUCTION

Parts List

- Parts List (by Vikings)
1. Set of Saddlebags
 2. Installation Instruction
 3. Mounting Hardware (See Fig.A)

Tools Needed

1. Adjustment Wrench
2. Flathead Screwdriver
3. Color Marker
4. Power Drill with 3/8-inch drill bit

Step 1

Ask a helper to hold the bag against the fender to find a suitable position to mount the bags. Once found, keep the bag steadily in the exact same position.

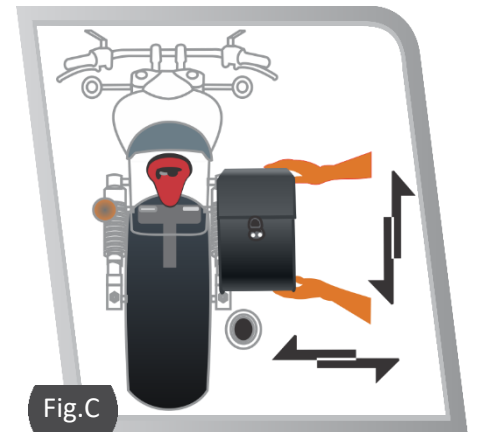
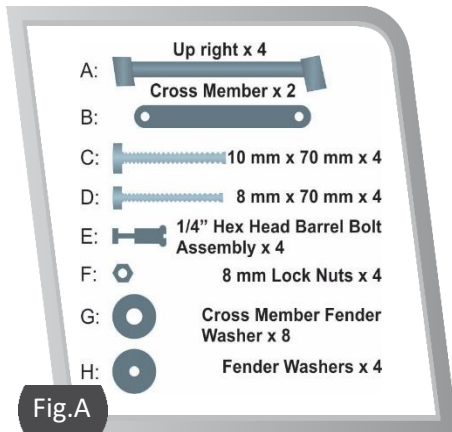

Step 2

Use a marker or paint to mark the position of the fender bolts onto the back of the bag.

Step 3

Place the longer end of one upright each at both marked points as shown in Fig. E. Place cross member under the opposite ends of upright and adjust so the holes in cross member match the holes in the bottom end of uprights. Mark the two bottom points.

Step 4

Drill all 4 marked points using a 1/4 - inch drill bit.

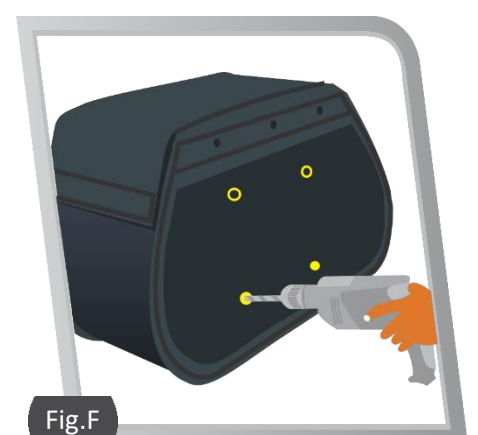
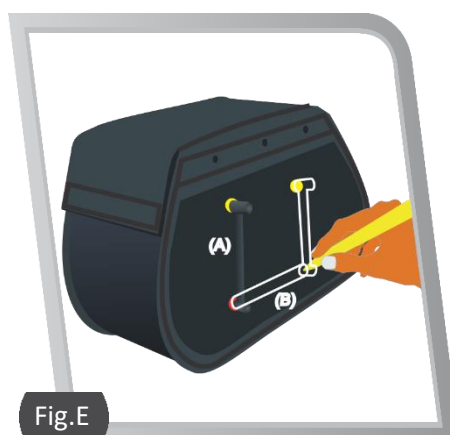
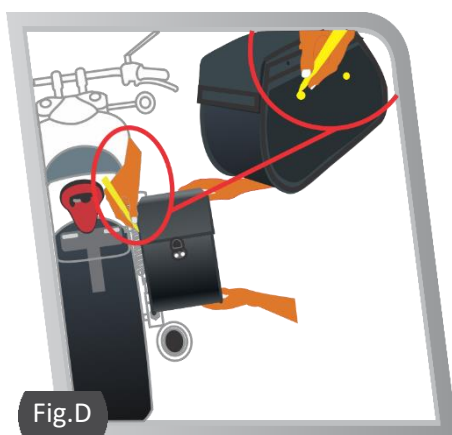



INSTALLATION INSTRUCTIONS

www.vikingbags.com



888-208-1949 |



support@vikingbags.com

VIKINGBAGS MOTORCYCLE HARD MOUNT INSTRUCTION

Step 5

The throw over installation is now complete.

Step 6

By now you should have the bracket permanently attached to the back of the bag and it should resemble Fig.H. Remove the fender bolts, and insert the top two bolts protruding out of the bag into the fender and tighten.

Step 7

Repeat the same process in order to install the other saddlebag. Please see the following tip for identical installation of both sides.

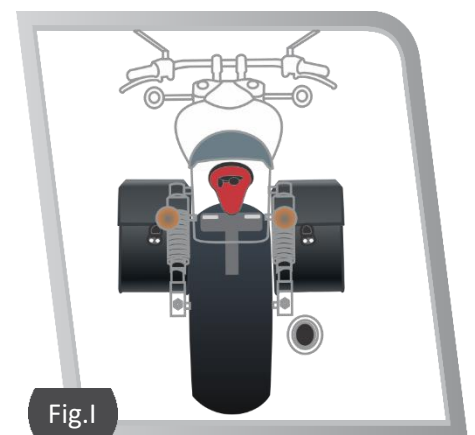
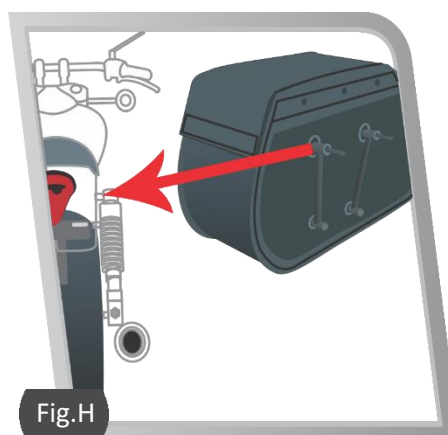
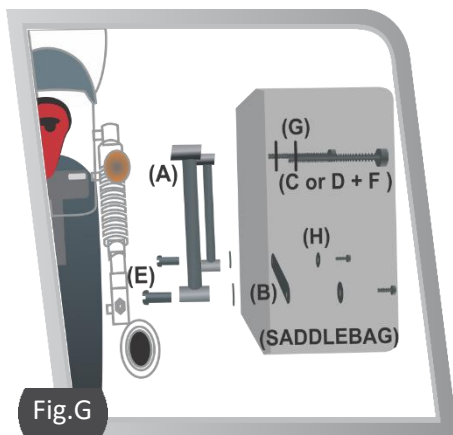

Tips

In order to ensure both bag's fitment is identical and to save time. After drilling the four holes' in the first bag place the back of the bag against the second undrilled bag. Access the drilled bag from inside and mark the four holes on to the back of the second bag.

Warnings

Avoid usage of the any mounting part that is impaired or is not working properly. If you are not sure about the installation process, please seek professional advice.

It is important to note that if you do not mount these saddlebags properly damage may be caused to the saddlebags and/or motorcycle. If bag are securely installed, no part of the mounting system or bags should touch the motorcycle while in operation.

Sporadically check for shifting of the bag and verify that no part of the mounting system is interfering with any part of the motorcycle while riding. This includes the drive train, suspension, brakes or wheels.

Do not attempt to use these saddlebags if the mounting instructions are unclear. It is important that you seek professional assistance from a qualified mechanic or dealer.

It is highly dangerous to operate a motorcycle if the saddlebags are not installed correctly. We suggest you find a motorcycle mechanic for further assistance in the event you have doubts about your abilities to install the product securely.

Make sure that mounting bolts do not hit the tire inside the fender. In case the bolts are too long, use the provided spacers to adjust for the excessive length.